

IMA

INTEGRATED MOTOR ROD-STYLE ACTUATOR

ENDURANCE TECHNOLOGY™

Patented



LINEAR SOLUTIONS MADE EASY

The longest lasting, high-force integrated actuator on the market!

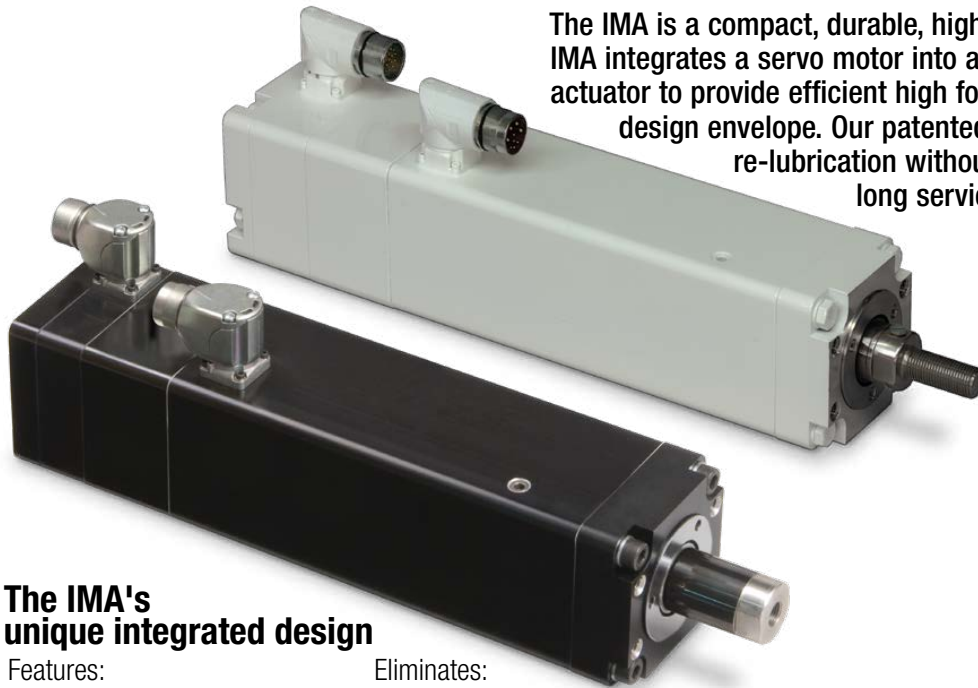

The IMA is a compact, durable, high force rod-style actuator. The IMA integrates a servo motor into a ball or roller screw-driven actuator to provide efficient high force in a compact lightweight design envelope. Our patented* design allows for easy re-lubrication without disassembly for extremely long service life.

*U.S. PATENT NO. 8,196,484

The IMA's unique integrated design

Features:

- Compact, lightweight design
- Long life
- High force
- High positional accuracy
- High efficiency
- Proven performance
- Ratings for extreme environments
- Compatibility
- Low inertia



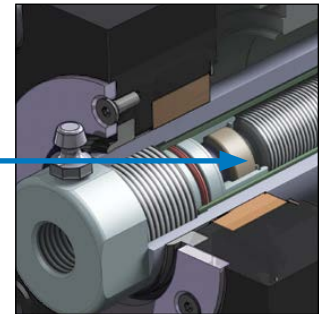

Eliminates:

- Couplers
- Adapters
- Belts
- Gears
- Unneeded assembly labor
- Forced air or water cooling
- Hydraulic systems
- Pneumatic systems
- Need for multiple vendors

**PATENTED
SCREW
LUBRICATION
SYSTEM FOR
EXTENDED
SERVICE LIFE**



TOLOMATIC'S ELECTRIC ROD-STYLE ACTUATORS

	ERD	RSA	RSX	GSA	IMA
					
	Rod-Style Actuator	Rod-Style Actuator	Rod-Style Actuator	Guided Rod-Style Actuator	Integrated Motor Rod-Style Actuator
Thrust up to:	35 kN (7,868 lbf)	58 kN (13,039 lbf)	133.5 kN (30,000 lbf)	4.23 kN (950 lbf)	30.6 kN (6,875 lbf)
Speed up to:	1473 mm/sec (58 in/sec)	3,124 mm/sec (123 in/sec)	760 mm/sec (29.9 in/sec)	3,124 mm/sec (123 in/sec)	1,334 mm/sec (52.5 in/sec)
Stroke Length up to:	1219 mm (48 in)	1,524 mm (60 in)	1500 mm (59 in)	914 mm (36 in)	457 mm (18 in)
Screw/Nut Type	Solid, Ball & Roller	Solid, Ball & Roller	Roller	Solid & Ball	Ball & Roller
<i>For complete information see www.tolomatic.com or literature number:</i>					
Literature Number:	2190-4000	3600-4166	2171-4001	3600-4166	2700-4000

(Not all models deliver maximum values listed, i.e.: Maximum thrust may not be available with maximum speed)

IMA - Integrated Motor Actuator

IMA Applications

Press Fitting System

- High Force
- Long Life



Valve / Process Control

- Efficient
- Accurate Positioning
- Quick Response

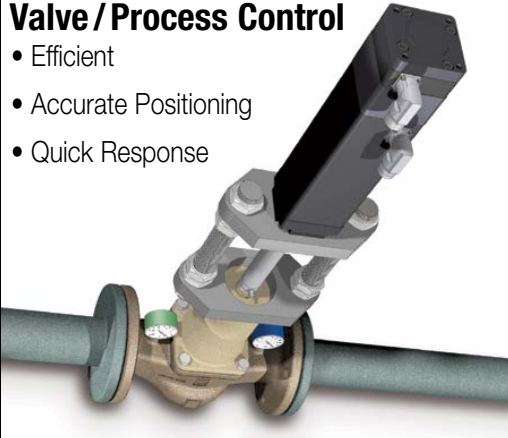

CONTENTS

- What is the IMA? 2
- IMA Applications 3
- IMA Features 4
- IMA Specs & Performance 8-14
- IMA Dimensions 15-18
- Application Data Worksheet 19
- Selection Guidelines 20
- Ordering 23

Spot Welding

- Compact, Lightweight
- Repeatable, High Force

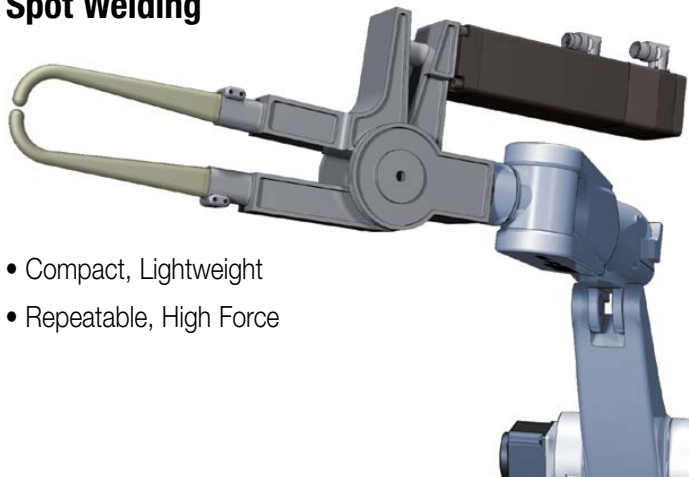

Fluid Dispensing

- Repeatable Force
- Smooth Velocity

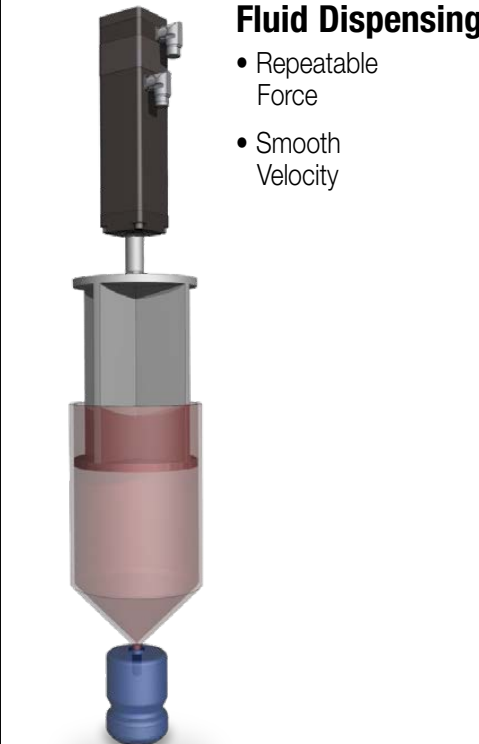

More Applications:

- Aerospace
- Animation
- Assembly
- Automated assembly
- Automatic tool changers
- Automotive
- Clamping
- Converting
- Conveyors
- Cycle testing
- Fillers
- Formers
- Hydraulic replacement
- Laser positioning
- Machine tools
- Material handling systems
- Medical equipment
- Military
- Molding
- Motion simulators
- Open / close doors
- Packaging equipment
- Parts clamping
- Patient lifts
- Pick & place
- Pneumatic replacement
- Precision grinders
- Product test simulations
- Riveting / fastening / joining
- Robot manipulator arms
- Sawmill equipment
- Semiconductor
- Stamping
- Table positioning
- Tension control
- Test stands
- Tube bending
- Volumetric pumps
- Water jet control
- Wave generation
- Web guidance
- Welding
- Wire winding

IMA INTEGRATED MOTOR ACTUATOR

ENDURANCE TECHNOLOGYSM

Endurance Technology features are designed for maximum durability to provide extended service life.

The IMA is a compact, durable, high force rod-style actuator with an IP65 rating. The IMA integrates a servo motor into a ball or roller screw-driven actuator to provide efficient high force in a compact lightweight design envelope. Our patented design allows for easy re-lubrication without disassembly for extremely long service life. Built-to-order in stroke lengths up to 450 mm (18") with your choice of screw technology.

• HIGH POSITIONAL ACCURACY •

SCREW ACCURACY

Roller Nut	± 0.0004"/ft.	± 0.0102mm/300mm
Ball Nut	± 0.002"/ft.	± 0.051mm/300mm

• REPLACEABLE ROD WIPER •

- Prevents contaminants from entering the actuator for extended life

• GREASE PORT •

- Screw re-lubrication system provides extended screw service life
- Convenient lubrication without disassembly (IMA22 is lubed for life and does not include grease port)

• INTEGRAL MOUNTING •

- Four metric threaded holes on front face are available for direct mounting or addition of customized options

• THREADED ROD END •

- Zinc plated alloy steel construction for corrosion resistance
- Provides a common interface to multiple rod end options

• THRUST TUBE •

- Steel thrust tube supports extremely high force capabilities
- Salt bath nitride treatment provides excellent corrosion resistance, surface hardness and is very resistant to adherence of weld slag, water and other potential contaminants

• MULTIPLE SCREW TECHNOLOGIES YOU CAN CHOOSE:

- Ball screws offer efficiency at a cost effective price
- Roller screws provide the highest thrust and life ratings available



• INTERNAL BUMPERS •

- Bumpers protect the screw and nut assembly from damage at end of stroke

• LIGHTWEIGHT ALUMINUM DESIGN •

- Black anodized extrusion design is optimized for rigidity and strength

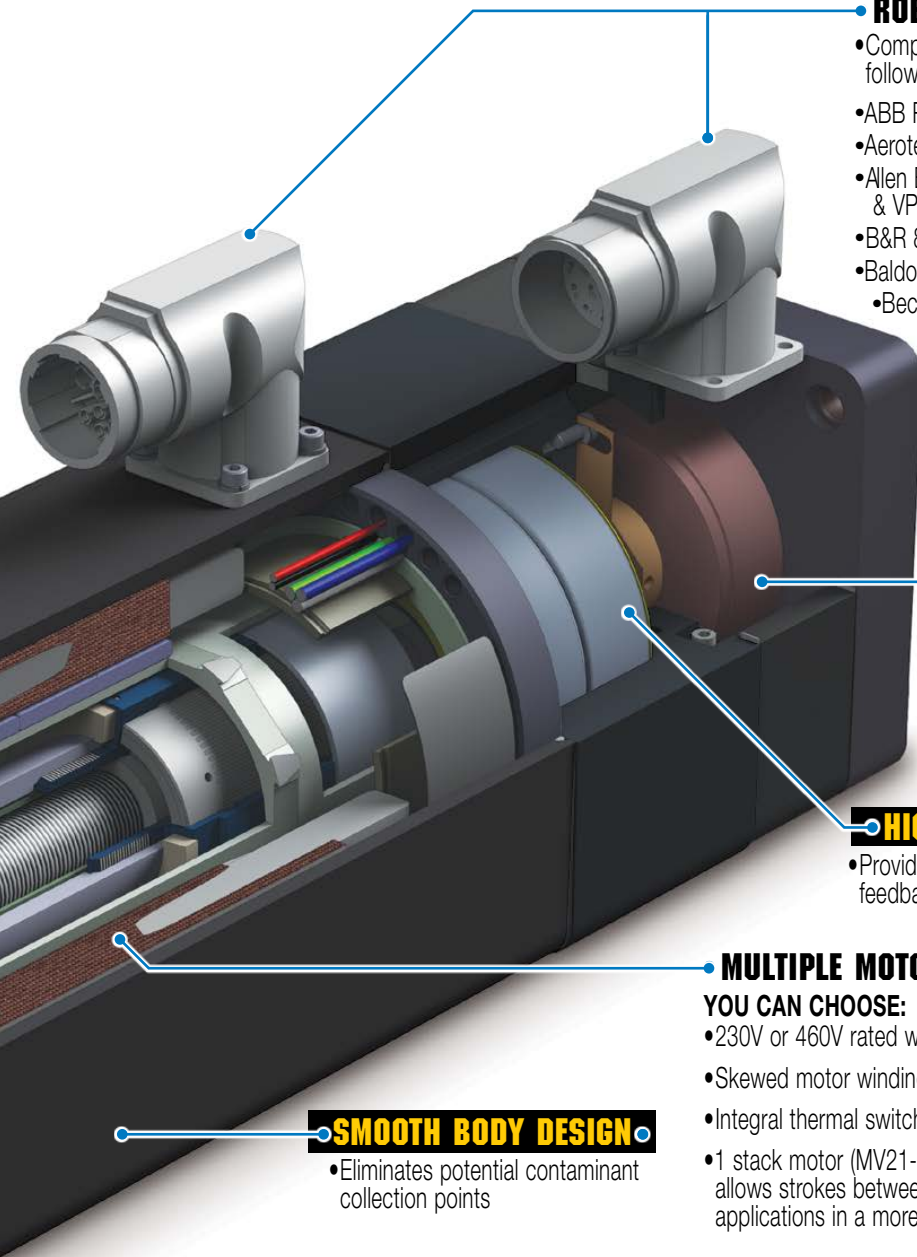

ROBOT & DRIVE/CONTROLLER COMPATIBILITY

- Compatible feedback, connector(s) and wiring to match the following robot & drive/controller manufacturers:
 - ABB Robot*
 - Aerotech BM*
 - Allen Bradley MP & VP
 - B&R 8LS*
 - Baldor BSM
 - Beckhoff AM8*
 - Bosch Rexroth MSK
 - Nidec/Control Techniques FM & NT
 - Fanuc Robot*
 - Kawasaki Robot*
 - Kollmorgen AKM*
 - Kuka Robot*
 - Lenze MCA
 - Motoman / Yaskawa Robot*
 - Nachi Robot*
 - Omron*
 - Parker MPP*
 - Schneider Electric SH*
 - SEW CMP*
 - Siemens 1F*
 - Stober*
- *Consult Tolomatic for lead time
- Tolomatic standard connector, wiring and flying lead cable can be used to integrate with servo drive manufacturers such as:
 - AMC • Copley • Elmo • + Others
- STAGGERED CONNECTORS for convenient installation

HIGH RESOLUTION FEEDBACK

- YOU CAN CHOOSE:**
- Incremental encoder
 - Multi-turn absolute encoder, Hiperface, Hiperface DSL, EnDat 2.2
 - Resolver

HIGH THRUST BEARING

- Provides complete support of screw and protects the feedback device from linear forces

MULTIPLE MOTOR WINDINGS

- YOU CAN CHOOSE:**
- 230V or 460V rated windings potted directly into actuator housing
 - Skewed motor windings provide minimal torque ripple for smooth linear motion
 - Integral thermal switch for over temperature protection
 - 1 stack motor (MV21-230V & MV41-460V) available for the IMA22 & IMA33, allows strokes between 3 and 6" providing the thrust needed for many applications in a more compact, lighter weight package

SMOOTH BODY DESIGN

- Eliminates potential contaminant collection points



Modifications:

- Contact Tolomatic for stainless steel, manual override or food grade versions of the IMA (See the white paint IMA on the next page)

OPTIONS

MOUNTING

- Front Face - Standard
- Side Mounting Holes, 2 sides & bottom (no photo)
- Mounting Plates
- Rear Clevis
- Front Flange
- Trunnion, Rear or Front

ROD END

- Internal Thread - Standard
- External Threads
- Clevis
- Spherical Eye
- Alignment Coupler

BRAKE

- 24V Spring held / electronically released

- IP67 • For protection against water and dust ingress

CABLES

- Signal Cable (5 & 10 m)
- Power Cable (5 & 10 m)

ARO

- Anti-Rotate

WHITE PAINT IMA

ENDURANCE TECHNOLOGYSM

Endurance Technology features are designed for maximum durability to provide extended service life.

The white epoxy IMA has all the features of the IMA shown on the previous pages plus features that are suited to challenging environments: Stainless steel rod, rod end, fasteners; food grade white paint; IP67 rating; Viton seals and food grade grease. The white paint IMA is a great option for the food & beverage processing environment. Contact Tolomatic for lead time

300 SERIES STAINLESS STEEL ROD

- Corrosion resistant 316 stainless steel thrust rod

GREASE PORT

- Pictured with plug, grease zerk also available. Both made with corrosion resistant 316 stainless steel. Replace plug with zerk to lubricate
- Screw relubrication system provides extended screw service life
- Convenient lubrication without disassembly (IMA22 is lubed for life and does not include grease port)

FIELD SERVICEABLE VITON[®] WIPER

- State-of-the-art wiper prevents contaminants from entering the actuator for extended life

IP67 RATED

- Static tested against ingress of dust and water for protection of internal components and long actuator life

IP67: Ingress Protection: **First Digit** = Solids, 6 = Dust Tight (No ingress of dust; complete protection against contact)
Second Digit = Liquids, 7 = Immersion up to 1 m (Ingress of water in harmful quantity shall not be possible when the enclosure is immersed in water under defined conditions of pressure and time up to 1 m of submersion)

300 SERIES STAINLESS STEEL FASTENERS

- For corrosion resistance even if white epoxy is removed
- Hex bolts for fewer collection points for contaminants in wash-down environments

FOOD GRADE PAINT

- FDA & USDA approved
- White paint reveals any foreign matter to ease clean-up

SMOOTH BODY DESIGN

- Fewer collection points for contaminants in wash-down environments

VITON® SEALS

- Viton®, a high performance elastomer, has a proven reputation for outstanding performance in hot and corrosive environments.

OPTIONS

MOUNTING

- Front Face - Standard
- Side Mounting Holes, 2 sides & bottom (no photo)
- Rear Clevis 
- Front Flange 
- Trunnion, Rear or Front 

MODIFICATIONS



- Contact Tolomatic for stainless steel, manual override or food grade versions of the IMA



Performance & Mechanical Specifications:

SERIES	STACK ¹	NUT/ SCREW	SCREW LEAD	DYNAMIC LOAD RATING (1 MIL. REV/S)	CONT. THRUST	PEAK THRUST	MAX. VELOCITY	BASE INERTIA ²	INERTIA PER UNIT OF STROKE	BREAK- AWAY TORQUE	BACK DRIVE FORCE ³
			mm	kN	kN	kN	mm/sec	kg-cm ²	kg-cm ² / mm	N-m	N
IMA22	1	BN05	5	5.72	0.89	1.45	356	0.9007	0.00014	0.34	218
	3	BN05	5	5.72	1.45	1.45	356	1.4859	0.00014	0.34	218
IMA33	1	BN05	5	8.71	1.62	4.45	305	2.7696	0.00031	0.54	347
	3	BN05	5	8.71	4.00	4.45	292	4.8709	0.00031	0.54	347
	1	BN10	10	5.40	0.81	2.44	610	2.7908	0.00036	0.54	173
	3	BN10	10	5.40	2.00	4.00	584	4.8922	0.00036	0.54	173
	1	BN20	20	11.39	0.41	1.23	1,219	3.0003	0.0014	0.54	89
	3	BN20	20	11.39	1.00	3.00	1,168	5.2184	0.0014	0.54	89
	1	RN04	4	41.10	2.0	6.0	244	2.7835	0.00036	0.60	434
	3	RN04	4	41.10	4.7	11.1	234	4.8847	0.00036	0.60	434
	1	RN05	5	45.42	1.6	4.7	305	2.7874	0.00041	0.60	347
	3	RN05	5	45.42	3.8	11.1	292	4.8937	0.00041	0.60	347
	1	RN10	10	45.42	0.8	2.3	610	2.8145	0.00048	0.60	173
	3	RN10	10	45.42	1.9	5.7	584	4.9208	0.00048	0.60	173
IMA44	3	BN05	5	17.95	7.78	8.90	292	10.0063	0.00209	0.63	405
	3	BN10	10	15.00	3.89	7.78	584	10.0459	0.00216	0.63	205
	3	BN25	25	11.29	1.56	3.11	1,334	10.3231	0.00265	0.63	80
	3	RN04	4	56.51	9.3	17.8	234	9.7764	0.00105	0.70	507
	3	RN05	5	56.51	7.3	14.7	292	9.7864	0.00113	0.70	405
	3	RN10	10	56.51	3.7	11.1	584	9.8334	0.00122	0.70	205
IMA55	3	BN05	5	29.87	13.13	13.35	201	77.9185	0.01757	1.06	681
	3	BN10	10	33.26	6.56	13.13	399	78.0428	0.01773	1.06	343
	3	BN20	20	24.59	3.28	8.21	797	78.5208	0.01836	1.06	169
	3	RN05	5	106.06	12.2	30.6	201	76.6569	0.01273	1.16	676
	3	RN10	10	106.06	6.1	15.3	399	76.7962	0.01291	1.16	338

			in	lbf	lbf	lbf	in/sec	lb-in ²	lb-in ² / in	in-lb	lbf
IMA22	1	BN05	0.197	1,286	200	325	14.0	0.3078	0.00123	3.0	49
	3	BN05	0.197	1,286	325	325	14.0	0.5078	0.00123	3.0	49
IMA33	1	BN05	0.197	1,958	365	1,000	12.0	0.9464	0.00266	4.8	78
	3	BN05	0.197	1,958	900	1,000	11.5	1.6645	0.00266	4.8	78
	1	BN10	0.394	1,214	183	549	24.0	0.9537	0.00313	4.8	39
	3	BN10	0.394	1,214	450	900	23.0	1.6717	0.00313	4.8	39
	1	BN20	0.788	2,560	92	276	48.0	1.0253	0.01211	4.8	20
	3	BN20	0.788	2,560	225	675	46.0	1.7832	0.01211	4.8	20
	1	RN04	0.157	9,236	450	1,350	9.6	0.9513	0.00314	5.3	98
	3	RN04	0.157	9,236	1,063	2,500	9.2	1.6694	0.00314	5.3	98
	1	RN05	0.197	10,211	350	1,050	12.0	0.9525	0.00358	5.3	78
	3	RN05	0.197	10,211	850	2,500	11.5	1.6723	0.00358	5.3	78
	1	RN10	0.394	10,211	175	525	24.0	0.9618	0.00413	5.3	39
	3	RN10	0.394	10,211	425	850	23.0	1.6815	0.00413	5.3	39
IMA44	3	BN05	0.197	4,035	1,750	2,000	11.5	3.4193	0.01811	5.6	91
	3	BN10	0.394	3,372	875	1,750	23.0	3.4329	0.01872	5.6	46
	3	BN25	0.985	2,537	350	700	52.5	3.5276	0.02303	5.6	18
	3	RN04	0.157	12,703	2,100	4,000	9.2	3.3412	0.00917	6.2	114
	3	RN05	0.197	12,703	1,650	3,300	11.5	3.3442	0.00984	6.2	91
	3	RN10	0.394	12,703	825	2,500	23.0	3.3602	0.01056	6.2	46
IMA55	3	BN05	0.197	6,714	2,950	3,000	7.9	26.626	0.15246	9.4	153
	3	BN10	0.394	7,476	1,475	2,950	15.7	26.6684	0.15385	9.4	77
	3	BN20	0.788	5,528	738	1,845	31.4	26.8318	0.15939	9.4	38
	3	RN05	0.197	23,843	2,750	6,875	7.9	26.1949	0.11051	10.3	152
	3	RN10	0.394	23,843	1,375	3,348	15.7	26.2425	0.11204	10.3	76

Performance data was validated using an aluminum face mount plate:
 IMA22 (8.25" x 7.0" x 0.7");
 IMA33 (8.25" x 7.0" x 0.7");
 IMA44 (9.0" x 9.0" x 0.7");
 IMA55 (9.0" x 9.0" x 1.0")
 Ambient Temp. = 77°F (25°C);
 Elevation < 3281' (1,000 m);
 Drive specifications: Sinusoidal Commutation and PWM Voltage Source

¹ Stack winding MV21 / 41
 3 Stack winding MV23 / 43
² Value given is for a zero stroke actuator † To be determined, visit www.tolomatic.com for up-to-date information
³ In vertical applications an unpowered IMA will require a brake to maintain position if the load on the actuator exceeds this value

IMA - Integrated Motor Actuator

Performance & Mechanical Specifications:

		IMA22 (1 STACK, MV21/41)	IMA22 (3 STACK, MV23/43)	IMA33 (1 STACK, MV21/41)	IMA33 (3 STACK, MV23/43)	IMA44	IMA55
FACE SIZE	mm	63.5	63.5	83	83	110	142
	in	2.5	2.5	3.3	3.3	4.4	5.6
STROKE	mm	76.2 to 304.8	152.4 to 304.8	76.2 to 457.2	152.4 to 457.2	152.4 to 457.2	152.4 to 457.2
	in	3.0 to 12.0	6.0 to 12.0	3.0 to 18.0	6.0 to 18.0	6.0 to 18.0	6.0 to 18.0
**BASE WEIGHT	kg	2.4	2.9	5.2	6.4	13	24.8
	lb	5.3	6.4	11.4	14.1	28.6	54.5
WEIGHT PER UNIT OF STROKE	kg/mm	0.0073	0.0073	0.0118	0.0118	0.0197	0.03771
	lb/in	0.2428	0.2428	0.6603	0.6603	1.1035	2.1115
SCREW LEAD ACCURACY	BN	in/ft = 0.002 mm/300 = 0.051 (0.004 in/ft for IMA33BN20 and IMA44BN25)					
	RN	in/ft = 0.0004 mm/300 = 0.010					
SCREW LEAD BACKLASH	BN	in = 0.004 mm = 0.1					
	RN	in = 0.0020 mm = 0.051					
TEMP RANGE	°C	Standard: 10 to 40; Extended: -20 to 60 (Contact Tolomatic if operation in the Extended Range is required)					
	°F	Standard: 50 to 104; Extended: -4 to 140 (Contact Tolomatic if operation in the Extended Range is required)					
IP RATING	Standard IP65, Optional IP67 (Static)						
REL. HUMIDITY (NON-CONDENSING)	5 to 90%						
SHOCK	20g peak, 6 msec duration						
VIBRATION	2.5g 30....2,000 Hz						

*In vertical applications an unpowered IMA will require a brake to maintain position if the load on the actuator exceeds this value

**Value given is for a zero stroke actuator

Motor Specifications:

		IMA22				IMA33				IMA44		IMA55	
WINDING/MOTOR VOLTAGE		MV21	MV41	MV23	MV43	MV21	MV41	MV23	MV43	MV23	MV43	MV23	MV43
TORQUE CONSTANT (Kt)	N-m/A Peak	0.37	0.74	0.49	0.93	0.61	1.21	0.62	1.21	0.61	1.20	0.76	1.51
	in-lb/A Peak	3.3	6.6	4.3	8.2	5.4	10.7	5.5	10.7	5.4	10.6	6.7	13.4
VOLTAGE CONSTANT (Ke)	V/Krpm Peak	51	102	61	122	81	160	79.8	154	78.1	153.1	100	201
CONTINUOUS STALL TORQUE	N-m	0.85	0.85	1.50	1.50	1.8	1.8	4.4	4.3	8.4	8.5	12.7	12.7
	in-lb	7.5	7.5	13.3	13.3	16	16	39	38	74	75	112	112
CONTINUOUS STALL CURRENT	A _{RMS}	1.6	0.8	2.2	1.15	2.1	1.1	5	2.5	9.7	5	11.8	5.9
PEAK TORQUE	N-m	2.54	2.54	4.5	4.5	5.4	5.4	13.2	12.9	25.1	25.4	31.6	31.6
	in-lb	22.5	22.5	39.9	39.9	48	48	117	114	222	225	280	280
PEAK CURRENT	A _{RMS}	4.8	2.4	6.6	3.45	6.3	3.3	15	7.5	29.1	15	29.5	14.8
RESISTANCE	Ohms	18.1	72.4	7.1	28.3	10	40.1	2.07	8.3	0.58	2.32	0.57	2.93
INDUCTANCE	mH	10.7	42	4.5	18	13.6	54.1	3.8	15	2.75	11.5	1.4	5.8
BUS VOLTAGE	V _{RMS}	230	460	230	460	230	460	230	460	230	460	230	460
SPEED @ RATED V	RPM	4,264				4,264		3,500		3,500		2,400	
NO. OF POLES		8											

RoHS Compliant Components;



Performance data was validated using an aluminum face mount plate: IMA22/33 (8.25" x 7.0" x 0.7"); IMA44 (9.0" x 9.0" x 0.7"); IMA55 (9.0" x 9.0" x 1.0"); Ambient Temperature = 77°F (25°C); Elevation < 3281' (1,000 m); Drive specifications: Sinusoidal Commutation and PWM Voltage Source



SPEED vs THRUST

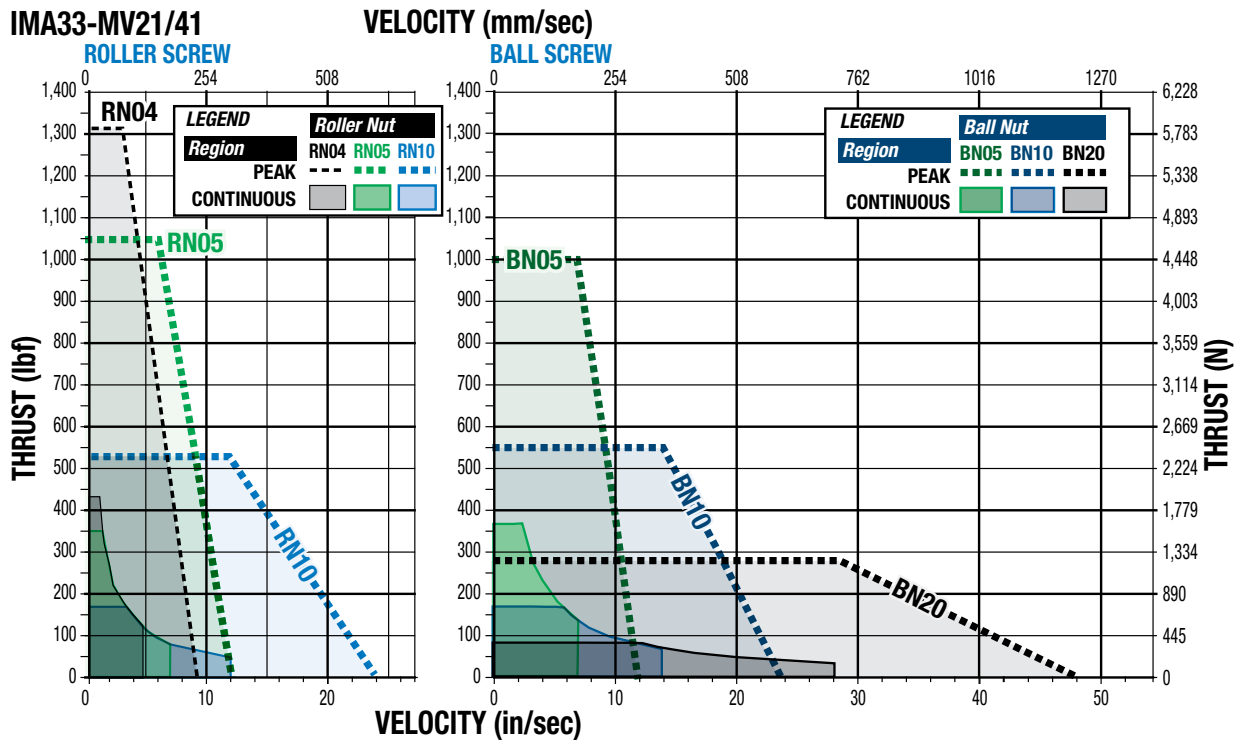
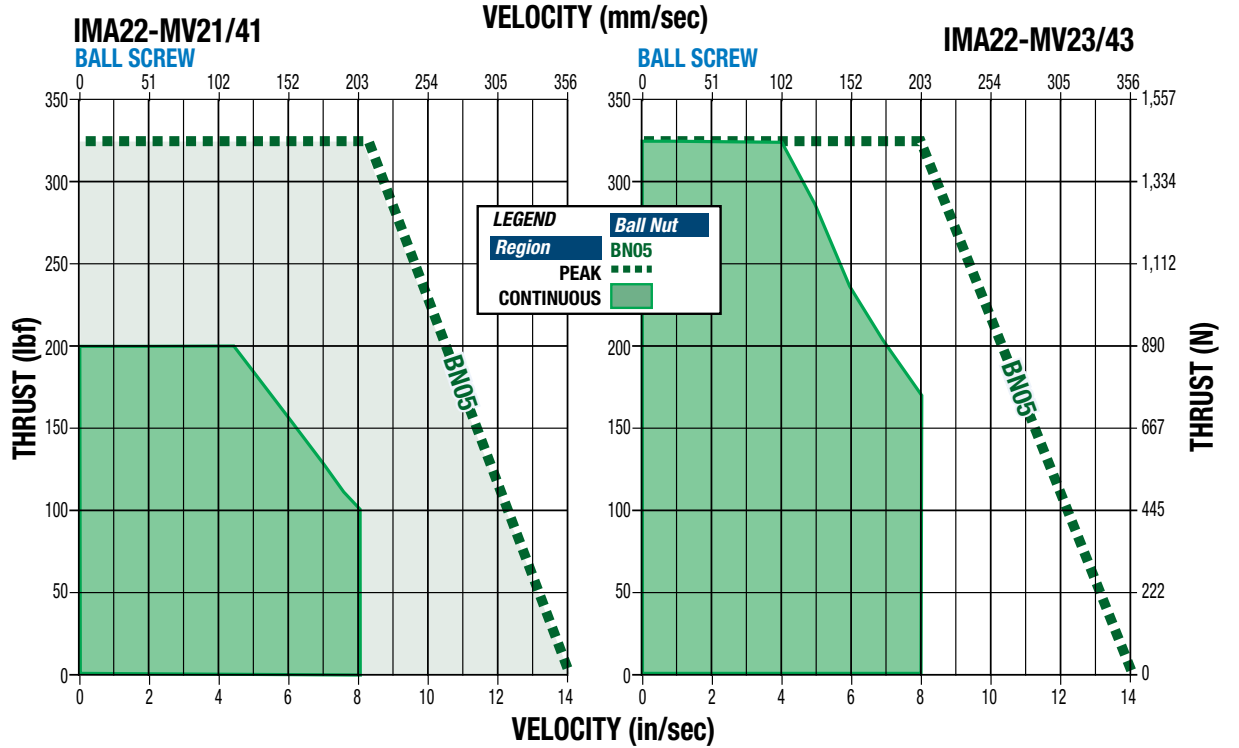

PEAK REGION is the maximum performance capabilities of the actuator system. Higher peak thrusts are achievable by servo motor actuator systems, so please consult Tolomatic before exceeding catalog rating.

CONTINUOUS REGION is defined as the RMS thrust and velocity limit that is derived from the thermal limits of the actuator system to achieve the dynamic load rating of the screw. (Example: Extend and retract under force 100% of the time with no dwells.)

IMA - Integrated Motor Actuator

SPEED vs THRUST

IMA33-MV23/43

VELOCITY (mm/sec)

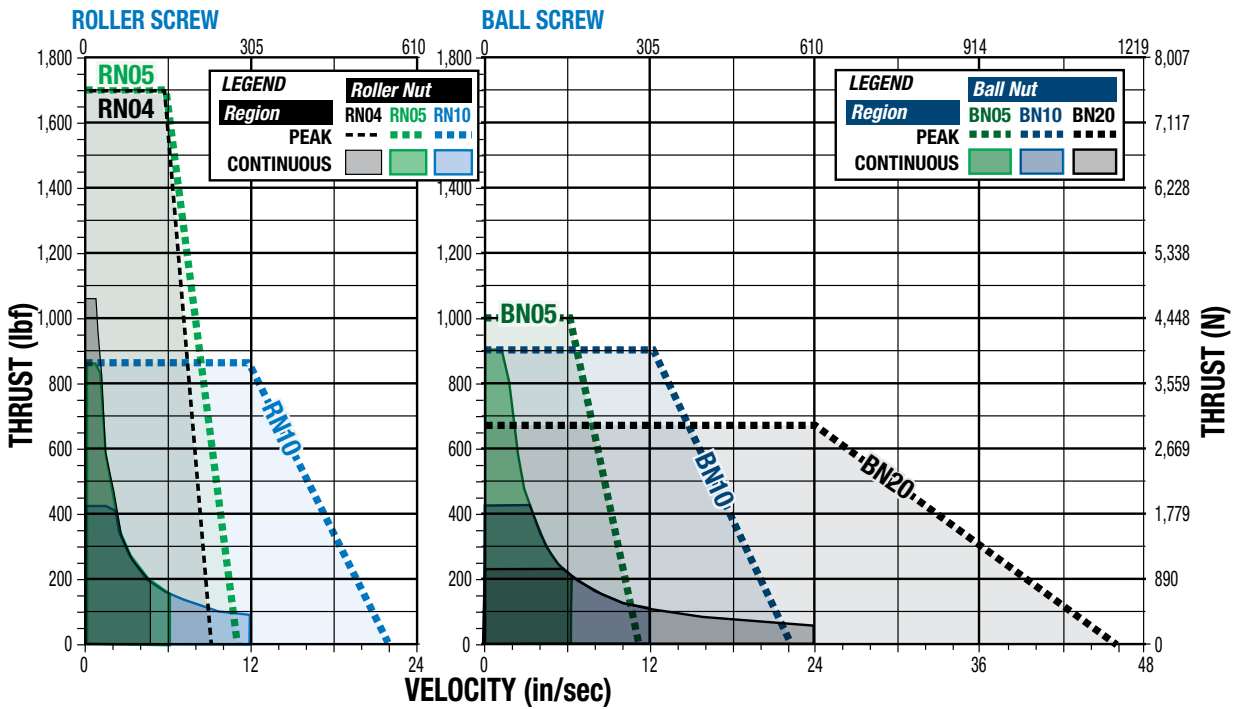

IMA44-MV23/43

VELOCITY (mm/sec)

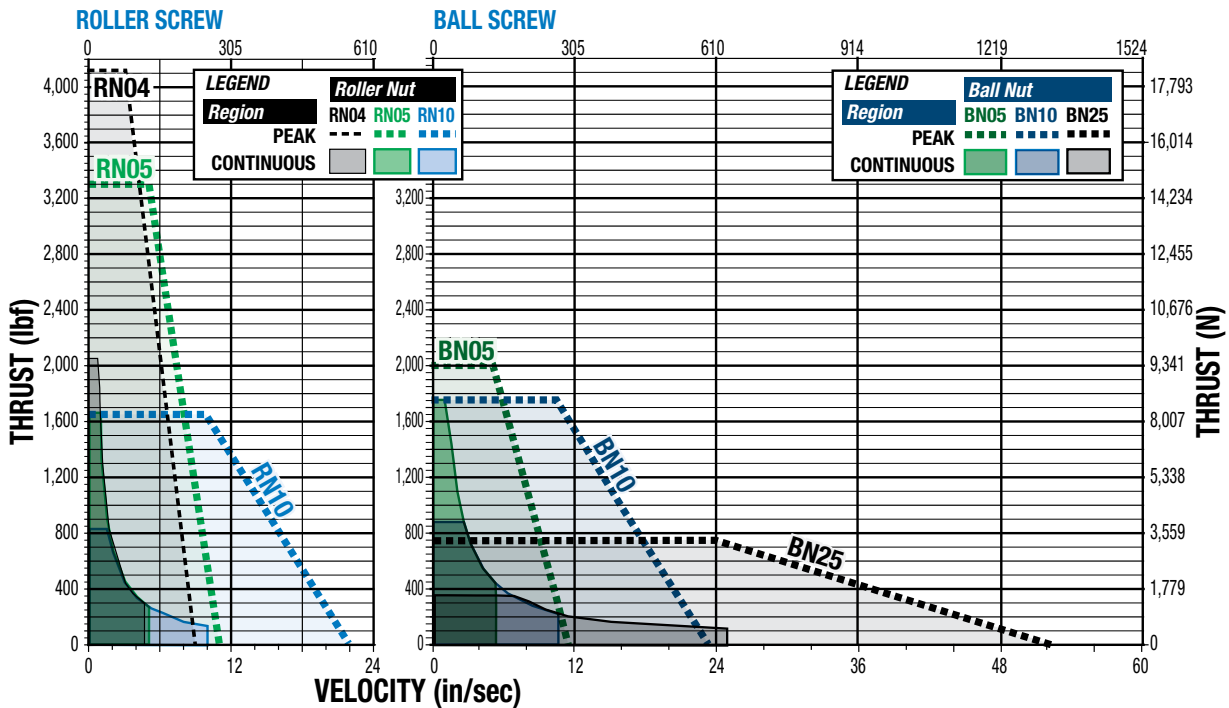

PEAK REGION is the maximum performance capabilities of the actuator system. Higher peak thrusts are achievable by servo motor actuator systems, so please consult Tolomatic before exceeding catalog rating.

CONTINUOUS REGION is defined as the RMS thrust and velocity limit that is derived from the thermal limits of the actuator system to achieve the dynamic load rating of the screw. (Example: Extend and retract under force 100% of the time with no dwells.)



SPEED vs THRUST

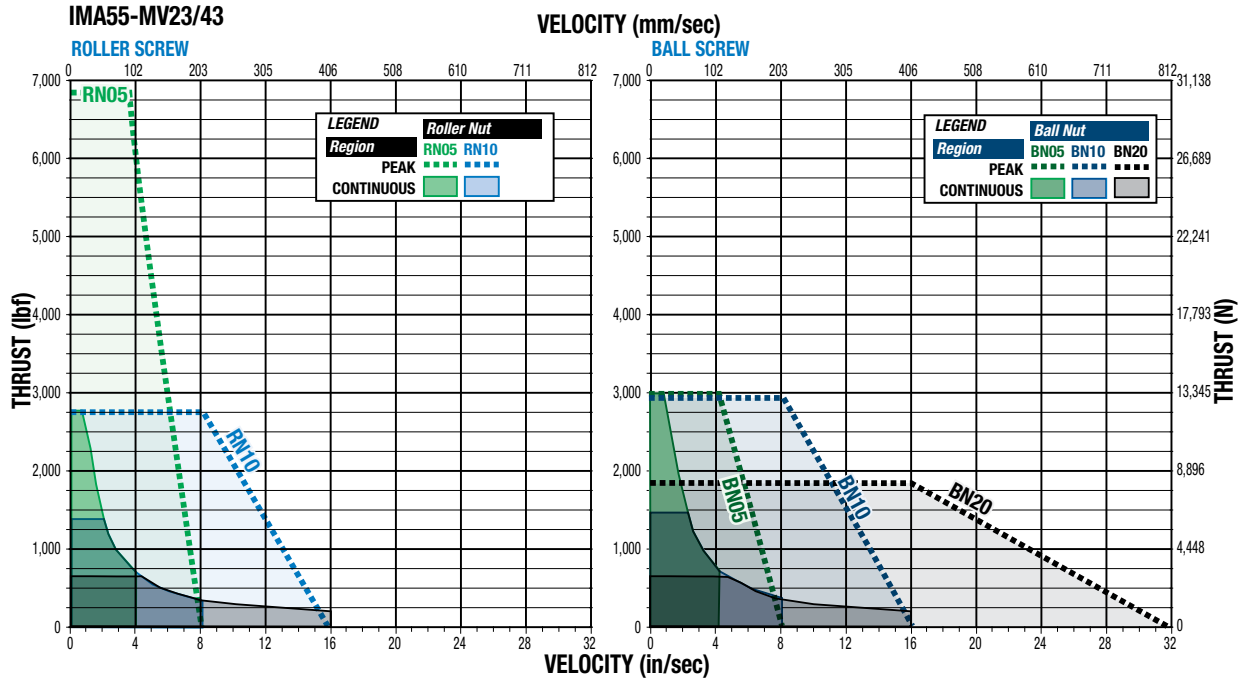

PEAK REGION is the maximum performance capabilities of the actuator system. Higher peak thrusts are achievable by servo motor actuator systems, so please consult Tolomatic before exceeding catalog rating.

CONTINUOUS REGION is defined as the RMS thrust and velocity limit that is derived from the thermal limits of the actuator system to achieve the dynamic load rating of the screw. (Example: Extend and retract under force 100% of the time with no dwells.)

CRITICAL SPEED

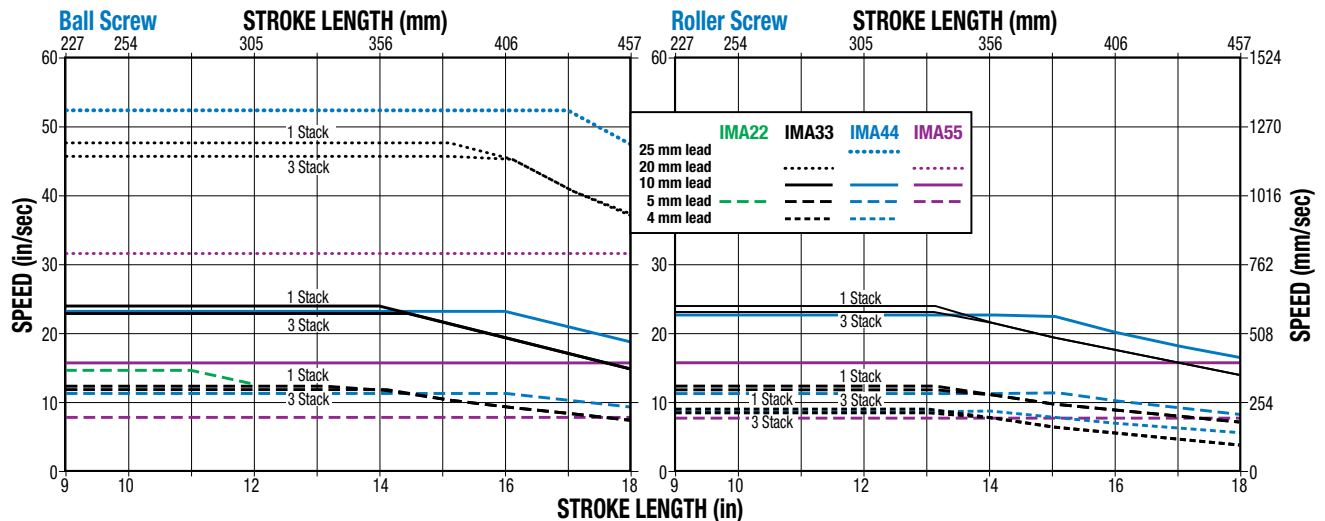

All curves represent properly lubricated and maintained actuators.

IMA - Integrated Motor Actuator

ROLLER SCREW BUCKLING LOAD

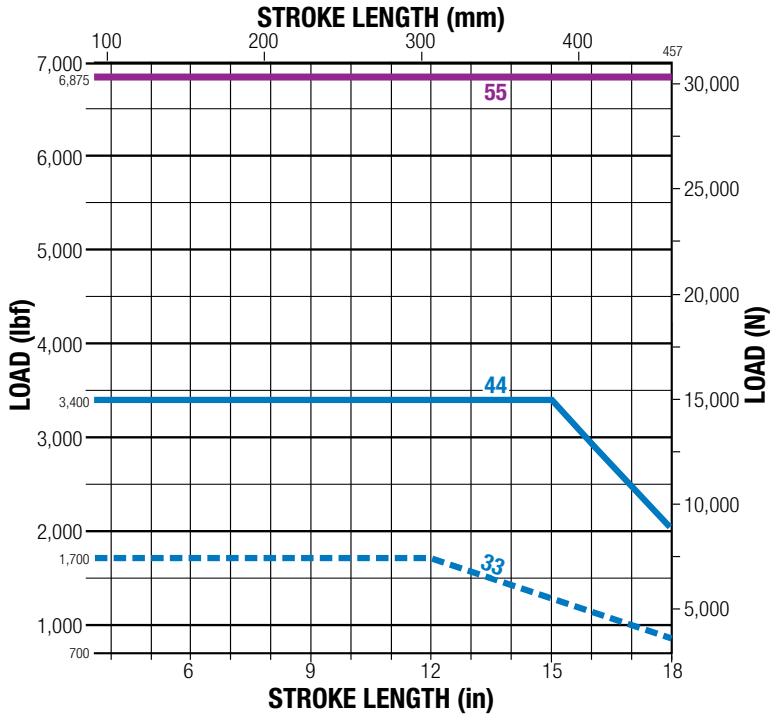

All curves represent properly lubricated and maintained actuators.

LIFE

BALL SCREW

ROLLER SCREW

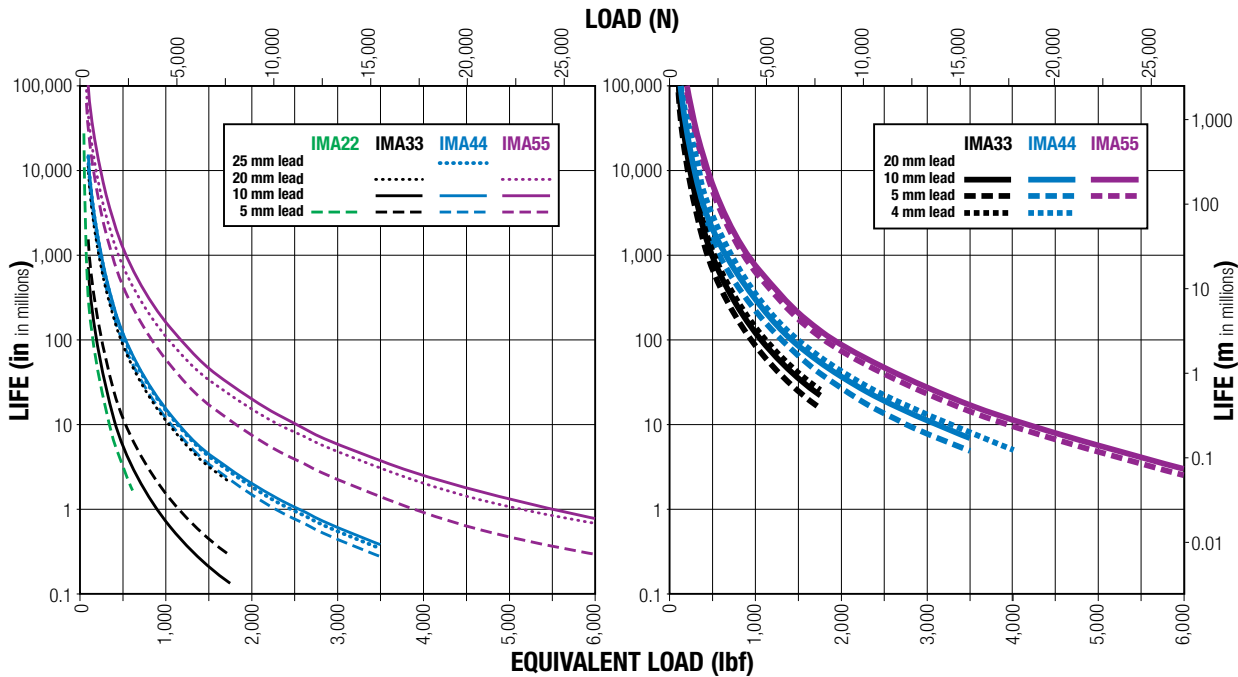

NOTE: The L_{10} expected life of a ball screw linear actuator is expressed as the linear travel distance that 90% of properly maintained ball screw manufactured are expected to meet or exceed. This is not a guarantee and this graph should be used for estimation purposes only.

The underlying formula that defines this value is:

$$L_{10} = \left(\frac{C}{P_e} \right)^3 \cdot \ell =$$

L_{10} Travel life in millions of units (in or mm), where:

- C = Dynamic load rating (lbf) or (N)
- P_e = Equivalent load (lbf) or (N)
- If load is constant across all movements then:
actual load = equivalent load
- ℓ = Screw lead (in/rev) (mm/rev)

Use the "Equivalent Load" calculation below, when the load is not constant throughout the entire stroke. In cases where there is only minor variation in loading, use greatest load for life calculations.

$$\text{Where: } P_e = \sqrt[3]{\frac{L_1(P_1)^3 + L_2(P_2)^3 + L_3(P_3)^3 + L_n(P_n)^3}{L}}$$

- P_e = Equivalent load (lbf) or (N)
- P_n = Each increment at different load (lbf) or (N)
- L = Total distanced traveled per cycle (extend + retract stroke)
[$L = L_1 + L_2 + L_3 + L_n$]
- L_n = Each increment of stroke at different load (in) or (mm)

IMA - Integrated Motor Actuator

RE-LUBRICATION RECOMMENDATION:

IMA33, IMA44, IMA55: IMA Lubrication requirements for electric actuators depend on the motion cycle (velocity, force, duty cycle), type of application, ambient temperature, environmental surrounding and various other factors.

For many general purpose applications, Tolomatic ball screw actuators are typically considered lubricated for life unless otherwise specified, such as those actuator models outfitted with a re-lubrication feature. For roller screw or ball screw actuators outfitted with a re-lubrication feature, Tolomatic recommends to re-lubricate the actuator at least once per year or every 1,000,000 cycles, whichever comes first, to maximize service life. For more demanding applications such as pressing, high frequency or other highly stressed applications, the re-lubrication interval for these actuators will vary and will need to be more frequent. In these demand-

ing applications, it is recommended to execute at least 5 full stroke moves every 5,000 cycles of operation (or more frequent if possible) to re-distribute the grease within the actuator.

Re-lubricate with Tolomatic Grease #2744-9099 into the grease zerk located on the rod end.

	Quantity	
IMA33	2.5 + [0.010 x L (mm)]	g
IMA44	4.8 + [0.010 x L (mm)]	g
IMA55	6.6 + [0.019 x L (mm)]	g
IMA33	0.09 + [0.009 x L (in)]	oz
IMA44	0.17 + [0.009 x L (in)]	oz
IMA55	0.23 + [0.017 x L (in)]	oz
L=stroke length (mm or in)		

⚠ In some applications oil may leak from the grease zerk. In contamination sensitive applications replace grease zerk with plug.

SIDE LOAD CONSIDERATIONS

The IMA integrated motor actuator is not meant to be used in applications where side loading occurs. Loads must be guided and supported. Loads should be aligned with the line of motion of the thrust rod. Side loading will affect the life of the actuator.



IMA SIDE LOAD SPECIFICATIONS

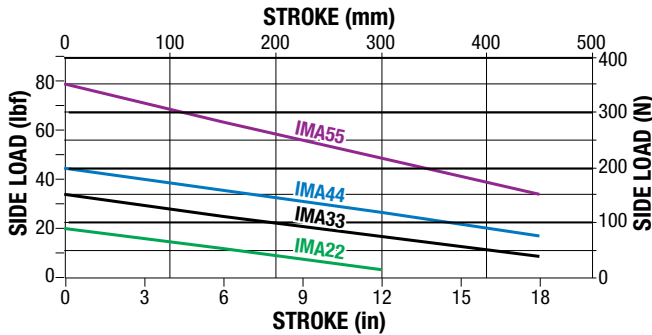

BRAKE CONSIDERATIONS

An un-powered IMA will require a brake to maintain its position if the force on the actuator exceeds Back Drive Force listed in the table on page IMA_8.

A brake can be used with the actuator to keep it from backdriving, typically in vertical applications. A brake may be used for safety reasons or for energy savings allowing the actuator to hold position when un-powered. See page IMA_23 for ordering information.

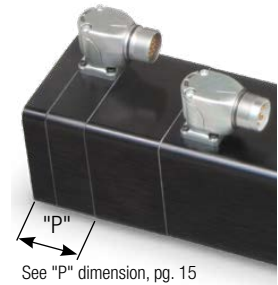

NOTE: The optional Spring-Applied / Electronically-Released Brake requires 24V power. Input current rating:
 IMA22 - 0.35 Amps;
 IMA33 - 0.43 Amps;
 IMA44 - 0.67 Amps;
 IMA55 - 0.66 Amps.



USE THE TOLOMATIC SIZING AND SELECTION SOFTWARE AVAILABLE ON-LINE AT www.tolomatic.com OR...

CALL TOLOMATIC AT 1-800-328-2174.

We will provide any assistance needed to determine the proper actuator for the job.

Brake Specifications:

	SERIES	IMA22	IMA33	IMA44	IMA55
ROTOR INERTIA	gm-cm ²	19	73	239	214
	oz-in ²	0.052	0.112	0.656	0.587
CURRENT	Amp	0.35	0.43	0.67	0.66
HOLDING TORQUE	N-m	1.6	4.0	9.0	16.4
	in-lb	14	35	89	145
ENGAGE TIME	mSec	75	40	25	15
DISENGAGE TIME	mSec	20	50	35	25
VOLTAGE	Vdc	24			

IMA - Integrated Motor Actuator

3D CAD available at www.tolomatic.com
Always use configured CAD solid model
to determine critical dimensions



Dimensions: **All Sizes**

DIMENSIONS

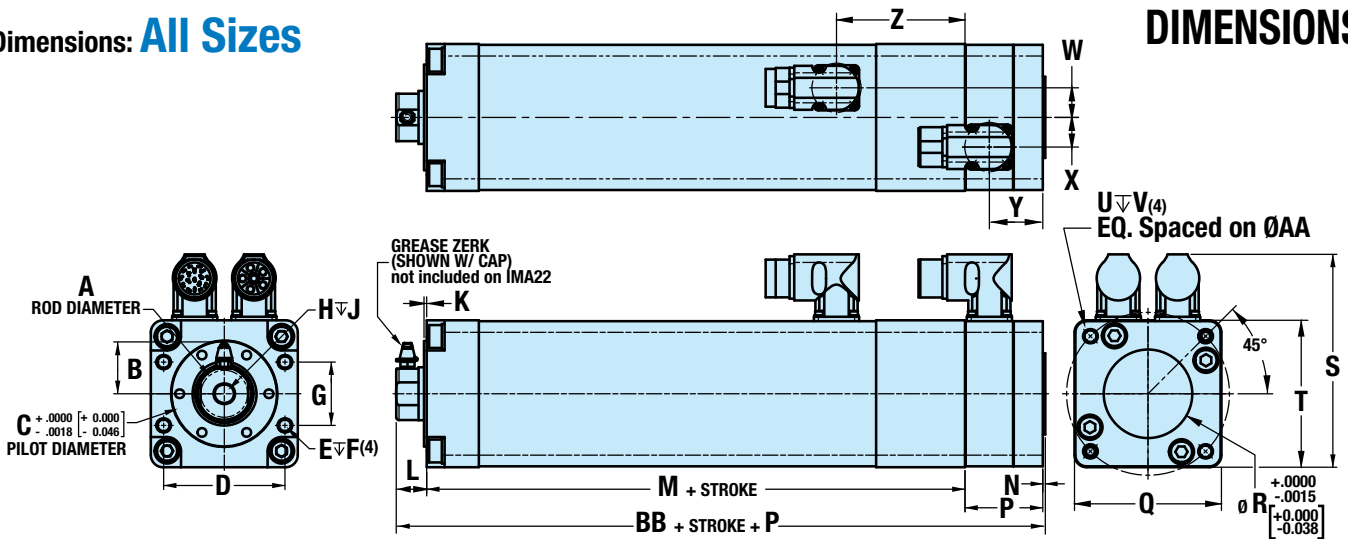

	IMA22	IMA33	IMA44	IMA55
A	25.38	30.13	38.08	57.13
B	-	28.3	32.3	41.9
C	48.000	60.000	72.000	100.000
D	54.00	69.00	85.00	110.00
E	M6 x 1.0	M8 x 1.25	M8 x 1.25	M12 x 1.75
F	13.2	14.5	17.1	22.5
G	20.00	36.00	55.00	65.00
H	M8 x 1.25	M12 x 1.25	M20 x 1.5	M27 x 2.0
J	16.5	22.2	25.9	38.1
K	1.5	1.5	1.5	1.5
L	17.3	17.3	16.8	24.1
M	109.8	153.7	200.0	266.2
N	1.5	1.5	1.5	1.5
P1	41.2	44.2	44.2	48.2
P2	86.7	80.8	80.0	96.8
P3	-	50.3	50.3	54.3
P4	-	93.5	89.0	96.8
P5	41.2	44.2	44.2	59.9
P6	86.7	80.8	80.0	96.8
P7	58.7	59.2	59.2	67.5
P8	96.3	100.6	99.1	111.5
P9	65.1	59.2	63.6	80.5
P10	107.2	100.6	99.1	122.9
Q	63.5	83.6	110.5	143.6
R	40.000	50.000	75.000	100.000
S1	104.4	124.6	151.4	184.3
S2	102.0	122.2	149.0	181.9
S3	-	113.5	140.4	173.3
T	63.5	83.6	110.5	143.6
U	M6 x 1.0	M8 x 1.25	M8 x 1.25	M12 x 1.75
V	13.5	16.5	16.5	20.5
W	9.5	16.8	22.2	22.2
X	9.5	16.8	22.2	22.2
Y	27.3	30.4	30.4	34.4
Z	60.6	73.1	77.9	86.9
AA	70.00	92.00	127.00	155.00
BB	128.6	172.5	218.3	291.8

Dimensions in millimeters

	IMA22	IMA33	IMA44	IMA55
A	0.999	1.186	1.499	2.249
B	-	1.11	1.27	1.65
C	1.8898	2.3622	2.8346	3.937
D	2.126	2.717	3.346	4.331
E	-	-	-	-
F	0.52	0.57	0.68	0.89
G	0.787	1.417	2.165	2.559
H	-	-	-	-
J	0.65	0.88	1.02	1.50
K	0.06	0.06	0.06	0.06
L	0.68	0.68	0.66	0.95
M	4.32	6.05	7.88	10.48
N	0.06	0.06	0.06	0.06
P1	1.62	1.74	1.74	1.90
P2	3.41	3.18	3.15	3.81
P3	-	1.98	1.98	2.14
P4	-	3.68	3.50	3.81
P5	1.62	1.74	1.74	2.36
P6	3.41	3.18	3.15	3.81
P7	2.31	2.33	2.33	2.66
P8	3.79	3.96	3.90	4.39
P9	2.56	2.33	2.50	3.17
P10	4.22	3.96	3.90	4.84
Q	2.50	3.29	4.35	5.66
R	1.5748	1.9685	2.9528	3.937
S1	4.11	4.91	5.96	7.26
S2	4.02	4.81	5.87	7.16
S3	-	4.47	5.53	6.82
T	2.50	3.29	4.35	5.66
U	-	-	-	-
V	0.53	0.65	0.65	0.80
W	0.38	0.66	0.88	0.88
X	0.38	0.66	0.88	0.88
Y	1.08	1.20	1.20	1.35
Z	2.39	2.88	3.07	3.42
AA	2.756	3.622	5.000	6.102
BB	5.06	6.79	8.6	11.49

Dimensions in inches

P1 =	Dx1 D1N	Digital Encoder
P2 =	Dx1 D1B	Digital Encoder with Brake
P3 =	DE2 D1N	*Digital Encoder (Nidec/Control Techniques NT)
P4 =	DE2 D1B	*Digital Encoder (Nidec/Control Techniques NT) w/ Brake
P5 =	Dx1 R1N	Resolver
P6 =	Dx1 R1B	Resolver with Brake

P7 =	Dx1 A1N DA2A2N	SICK Hiperface SICK Hiperface DSL
P8 =	Dx1 A1B DA2A2B	SICK Hiperface w/ Brake SICK Hiperface DSL w/ Brake
P9 =	Dx1 H1N	Heidenhain Endat 2.2
P10 =	Dx1 H1B	Heidenhain Endat 2.2 w/ Brake
S1 =	DT1, DE1 DL1, DS1	Tolomatic Standard, Nidec/Control Techniques FM, Lenze, Siemens

KEY FEATURES: 1-STACK & 3-STACK MOTORS

IMA22

SERIES		MV21/41	MV23/43
STROKE	mm	76.2 to 304.8	152.4 to 304.8
	in	3.0 to 12.0	6.0 to 12.0
PEAK THRUST	N	up to 1,446	up to 1,446
	lbf	up to 325	up to 325

IMA33

SERIES		MV21/41	MV23/43
STROKE	mm	76.2 to 457.2	152.4 to 457.2
	in	3.0 to 18.0	6.0 to 18.0
PEAK THRUST	N	up to 4,673	up to 7,562
	lbf	up to 1,050	up to 1,700

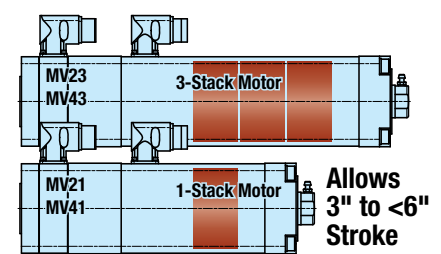

S2 =	DB1	Bosch MSK Motor Series
S3 =	DE2	Nidec/Control Techniques NT Series
*Uses Box Mount Connectors (IP67 not available) Not available as standard on IMA22		

IMA - Integrated Motor Actuator

Dimensions: Rod End Options

EXTERNAL THREADED ROD END (MET)

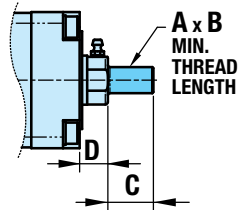
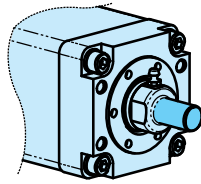

CLEVIS ROD END (RCL)

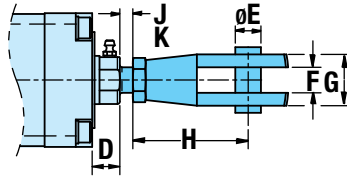
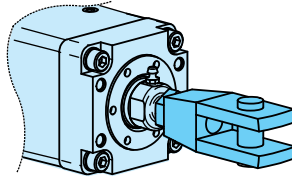

SPHERICAL ROD EYE (SRE)

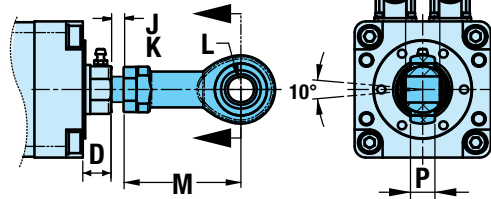
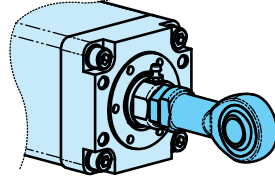

ALIGNMENT COUPLER (ALC + MET)

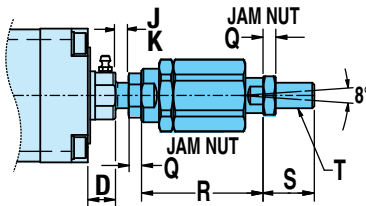
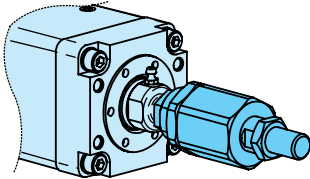

ALIGNMENT COUPLER FEMALE (ALC)

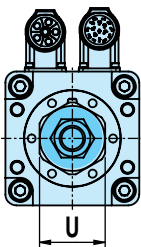
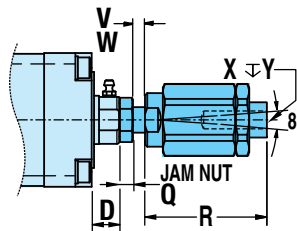
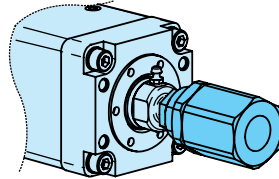

	IMA22	IMA33	IMA44	IMA55
A	M10 x 1.25	M16 x 1.5	M20 x 1.5	M27 x 2.0
B	22.1	34.3	41.4	38.1
C	24.6	37.3	44.5	50.8
D	17.3	17.3	16.8	24.1
E	10.00	16.00	20.00	30.00
F	10.0	16.0	20.0	30.0
G	20.0	32.0	40.0	55.0
H	45.0	72.0	90.0	123.5
J	9.1	13.2	14.2	10.1
K	2.5	3.0	3.0	5.1
L	10.00	16.00	20.00	30.00
M	48.0	72.0	87.0	123.5
N	14.0	21.0	25.0	37.0
P	12.5	15.0	18.0	25.0
Q	5.0	8.0	10.0	13.5
R	53.0	76.0	82.0	93.0
S	20.0	32.0	40.0	54.0
T	M10 x 1.25	M16 x 1.5	M20 x 1.5	M27 x 2.0
U	30.0	41.0	42.0	55.0
V	-	-	11.0	11.0
W	-	-	4.1	2.4
X	-	-	M20 x 1.5	M27 x 1.75
Y	-	-	42.0	54.0

Dimensions in millimeters

	IMA22	IMA33	IMA44	IMA55
A	-	-	-	-
B	0.87	1.35	1.63	1.80
C	0.97	1.47	1.75	2.00
D	0.68	0.68	0.66	0.95
E	0.394	0.630	0.787	1.181
F	0.39	0.63	0.79	1.18
G	0.79	1.26	1.57	2.17
H	1.77	2.83	3.54	4.86
J	0.36	0.52	0.56	0.40
K	0.10	0.12	0.12	0.20
L	0.394	0.630	0.787	1.181
M	1.89	2.84	3.43	4.86
N	0.55	0.83	0.98	1.46
P	0.49	0.59	0.71	0.94
Q	0.20	0.32	0.39	0.53
R	2.09	2.99	3.23	3.66
S	0.79	1.26	1.57	2.16
T	-	-	-	-
U	1.18	1.61	1.65	2.17
V	-	-	0.43	0.43
W	-	-	0.16	0.09
X	-	-	-	-
Y	-	-	1.65	2.13

Dimensions in inches

Dimensions: Mounting Options

DIMENSIONS

FRONT FLANGE MOUNT (FFG)

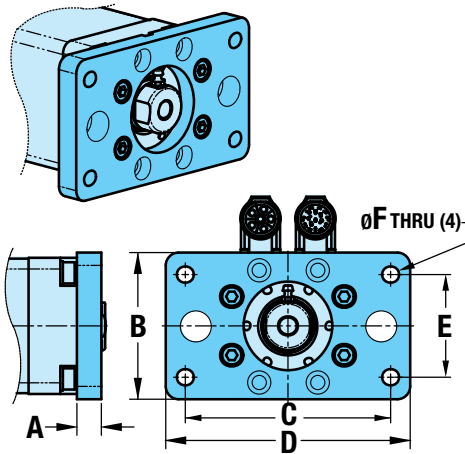

FRONT TRUNNION MOUNT (TRF)

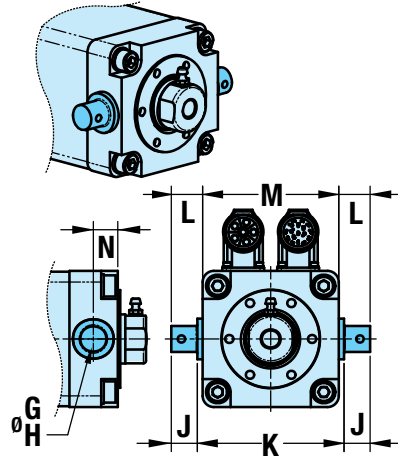

	IMA22	IMA33	IMA44	IMA55
A	11.2	15.0	16.0	17.8
B	67.3	87.0	110.5	150.0
C	100.00	126.00	150.00	230.00
D	117.3	150.0	170.0	260.0
E	50.00	63.00	75.00	115.00
F	8.7	12.3	14.7	16.7
G	11.99	15.98	19.99	24.99
H	11.96	15.95	19.96	24.97
J	8.6	16.0	20.1	24.9
K	68.0	90.0	123.0	160.0
L	10.9	19.2	26.3	33.1
M	63.5	83.6	110.5	143.6
N	15.0	15.0	21.0	28.0
Q	26.000 ¹	32.000	50.000	60.000
R	45.000 ²	60.000	90.000	110.000 ⁴
S	10.000 ³	12.000	16.000	20.000 ⁵
T	20.00	24.00	36.00	40.00
U	13.00	16.00	22.00	27.00
V	11.99	15.98	19.99	24.99
W	11.96	15.95	19.96	24.97
X	8.6	16.0	20.1	24.9
Y	68.0	90.0	123.0	160.0
Z	10.9	19.2	26.3	33.1
AA	63.5	83.6	110.5	143.6
BB	15.0	20.0	25.0	32.0

Dimensions in millimeters

REAR CLEVIS MOUNT (PCD)

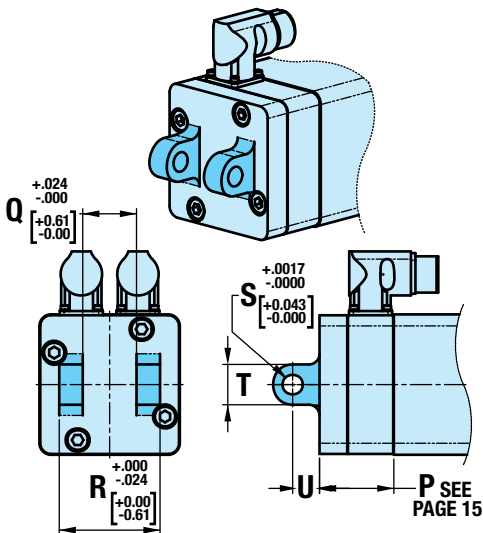

1	+0.520mm/-0.000mm
2	+0.000mm/-0.620mm
3	+0.036mm/-0.000mm
4	+0.000mm/-0.870mm
5	+0.052mm/-0.000mm

	IMA22	IMA33	IMA44	IMA55
A	0.44	0.59	0.63	0.70
B	2.65	3.43	4.35	5.91
C	3.937	4.961	5.906	9.055
D	4.62	5.91	6.69	10.24
E	1.969	2.480	2.953	4.528
F	0.34	0.48	0.58	0.66
G	0.472	0.629	0.787	0.984
H	0.471	0.628	0.786	0.983
J	0.34	0.63	0.79	0.98
K	2.68	3.54	4.84	6.30
L	0.43	0.76	1.04	1.30
M	2.50	3.29	4.35	5.66
N	0.59	0.59	0.83	1.10
Q	1.0236 ¹	1.2598	1.9685	2.3622
R	1.7717 ²	2.3622	3.5433	4.3307 ⁴
S	0.3937 ³	0.4724	0.6299	0.7874 ⁵
T	0.787	0.945	1.417	1.575
U	0.512	0.630	0.866	1.063
V	0.472	0.629	0.787	0.984
W	0.471	0.628	0.786	0.983
X	0.34	0.63	0.79	0.98
Y	2.68	3.54	4.84	6.30
Z	0.43	0.76	1.04	1.30
AA	2.50	3.29	4.35	5.66
BB	0.59	0.79	0.98	1.26

Dimensions in inches

REAR TRUNNION MOUNT (TRR)

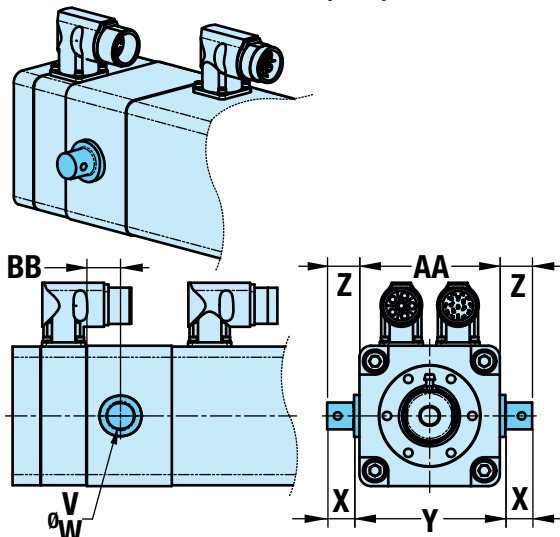

1	+0.0205"/-0.0000"
2	+0.0000"/-0.0244"
3	+0.0014"/-0.0000"
4	+0.0000"/-0.0343"
5	+0.0020"/-0.0000"

IMA - Integrated Motor Actuator

3D CAD available at www.tolomatic.com
Always use configured CAD solid model
to determine critical dimensions



Dimensions: Options

SIDE MOUNTING (MST)

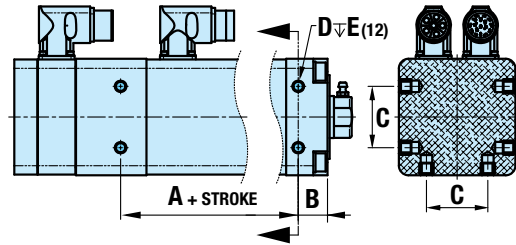
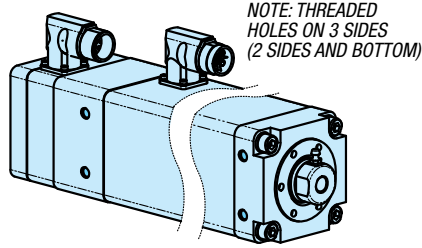

MOUNTING PLATES (MP2)

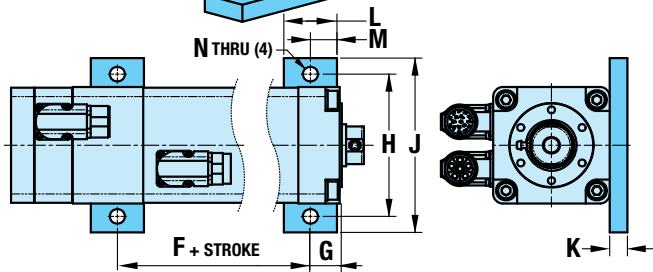
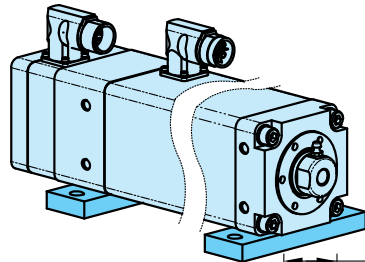

ANTI ROTATE (ARO)

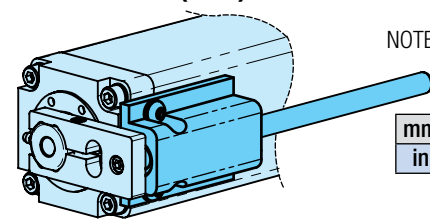

NOTE: When ARO is used together with FFG, stroke is reduced by dimension below

	IMA22	IMA33	IMA44	IMA55
mm	7.6	11.4	13.0	11.2
in	0.30	0.45	0.51	0.44

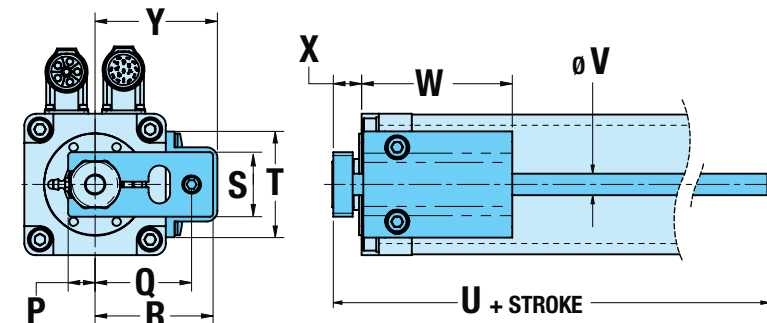

	IMA22	IMA33	IMA44	IMA55
A	67.8	100.7	143.0	191.2
B	20.0	21.0	25.0	30.0
C	34.00	44.00	50.00	85.00
D	M6 X 1.0	M8 x 1.25	M8 x 1.25	M12 x 1.75
E	13.1	14.5	17.1	22.5
F	67.8	100.7	143.0	191.2
G	20.0	21.0	25.0	30.0
H	80.00	102.00	130.00	170.00
J	100.0	125.0	155.0	200.0
K	11.0	12.7	12.7	20.0
L	30.0	38.1	38.1	50.0
M	15.0	19.1	19.1	0.5
N	8.7	10.7	10.7	15.1
P	12.7	15.9	19.8	31.8
Q	43.3	57.0	70.5	95.1
R	51.2	69.7	83.2	109.7
S	34.8	38.1	45.9	68.2
T	46.2	62.7	62.7	106.7
U	81.0	105.2	108.5	142.5
V	9.5	12.7	12.7	19.1
W	65.0	89.0	93.0	115.6
X	16.1	16.1	15.5	22.8
Y	54.9	72.3	85.7	118.3

Dimensions in millimeters

	IMA22	IMA33	IMA44	IMA55
A	2.67	3.97	5.63	7.53
B	0.79	0.83	0.98	1.18
C	1.339	1.732	1.969	3.346
D	-	-	-	-
E	0.52	0.57	0.68	0.89
F	2.67	3.97	5.63	7.53
G	0.79	0.83	0.98	1.18
H	3.150	4.016	5.118	6.693
J	3.94	4.92	6.10	7.87
K	0.43	0.50	0.50	0.79
L	1.18	1.50	1.50	1.97
M	0.59	0.75	0.75	0.98
N	0.34	0.42	0.42	0.59
P	0.50	0.63	0.78	1.25
Q	1.71	2.24	2.78	3.74
R	2.02	2.75	3.28	4.32
S	1.37	1.50	1.81	2.69
T	1.82	2.47	2.47	4.20
U	3.19	4.14	4.27	5.60
V	0.38	0.50	0.50	0.75
W	2.56	3.50	3.66	4.55
X	0.63	0.63	0.61	0.90
Y	2.16	2.85	3.38	4.66

Dimensions in inches

The IMA is matched to your drive/controller choice

The IMA has been successfully integrated with the following servo drive/controller and robot companies:

Controller/ Drive Manufacturers

- Aerotech BM*
- Allen Bradley MP & VP
- B&R 8LS*
- Baldor BSM
- Beckhoff AM8*
- Bosch Rexroth MSK
- Kollmorgen AKM*
- Lenze MCA
- Nidec/Control Techniques FM & NT
- Omron*
- Parker MPP*
- Schneider Electric SH*
- SEW CMP*
- Siemens 1F
- Stober*
- Others

Robot Manufacturers

- ABB*
- Fanuc*
- Kawasaki*
- Kuka*
- Motoman*
- Nachi*
- Others

* Consult Tolomatic for lead time



Contact Tolomatic if your preferred servo drive/controller or robot supplier is not listed above.



Licensed Partner

For additional information regarding the integration of the IMA to an Allen Bradley/Rockwell drive see tech note linked below:

[3600-4187_TN_IMA-AB-servo.pdf](#)

The IMA is the most rigorously tested Tolomatic product yet

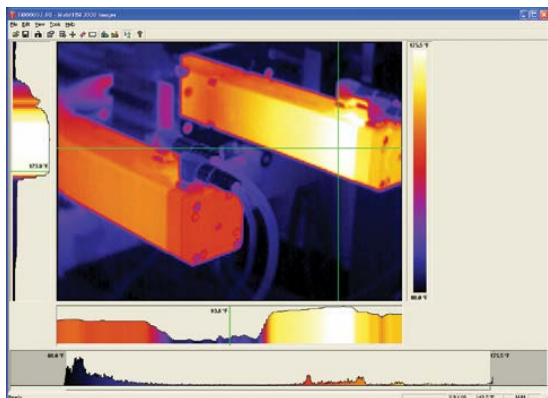

Cutting edge products like the IMA don't just fall into place. Over 20,000 hours of testing were required to prove the design that ships today. Thermal imaging, dynamic loading and other state-of-the-art techniques give us the confidence to stand behind our published performance data.

IMA - Integrated Motor Actuator

Selection Guidelines

1 ESTABLISH MOTION PROFILE

Using the application stroke length, desired cycle time and loads establish the motion profile details.

2 COMPARE OPERATING (PEAK) THRUST AND SPEED TO OPERATING REGION

Calculate the application required operating (peak) thrust and speed and compare to tables on pages IMA_8-9. The calculated thrust and speed must fall within the operating region of the actuator.

3 COMPARE SEVERE DUTY (CONTINUOUS) THRUST AND SPEED TO SEVERE DUTY REGION

Calculate the RMS thrust and speed required and compare to tables on pages IMA_8-9. The calculated thrust and speed must fall within the severe duty region. See complete instructions on page IMA_14 for help calculating continuous force.

$$T_{RMS} = \sqrt{\frac{\sum (T_i^2 \times t_i)}{\sum (t_i)}} \quad v_{RMS} = \sqrt{\frac{\sum (V_i^2 \times t_i)}{\sum (t_i)}}$$

4 CONSIDER SCREW/NUT CHOICES

Choose roller nuts for its longer life (see Life graph on page IMA_13) and higher peak loads (see graphs on pages IMA_10 & 11). Ball nuts are cost competitive and more efficient (see table on page IMA_8).

SCREW ACCURACY

Roller Nut	± 0.0004"/ft.	± 0.0102mm/300mm
Ball Nut	± 0.002"/ft.	± 0.051mm/300mm

5 VERIFY CRITICAL SPEED OF THE SCREW

Verify that the application's peak linear velocity does not exceed the critical speed value for the size and lead of the screw selected.

6 VERIFY AXIAL BUCKLING STRENGTH OF THE SCREW (ROLLER SCREW)

Verify that the peak thrust does not exceed the critical buckling force for the size of the screw selected.

7 MOTOR WINDINGS & VOLTAGES

Choose motor windings optimized for 230 Vac and 460 Vac voltage busses. The 1 stack motor (MV21-230V & MV41-460V), available for the IMA22/33, allows strokes between 3 and 6" providing the thrust needed for many applications in a more compact, lighter weight package

8 CALCULATE LUBRICATION INTERVAL

See page IMA_14 for an overview and IMA Users Guide (#2700-4001) for complete instructions to calculate lubrication interval.

9 TEMPERATURE

The IMA is intended to operate in an environment with an ambient temperature between 50-104°F, (10-40°C). Performance should be de-rated if the ambient temperature is above 77°F (25°C). Contact the factory if the ambient temperature does not fit within this range. NOTE: Temperature of

the actuator's body can approach 180°F (82°C) in aggressive applications. Adequate clearance to ensure actuator's ambient conditions do not rise drastically should be allowed.

10 BRAKE CONSIDERATIONS

An un-powered IMA will require a brake to maintain its position if the force on the actuator exceeds Back Drive Force listed in the table on page IMA_8.

A brake can be used with the actuator to keep it from back-driving, typically in vertical applications. A brake may be used for safety reasons or for energy savings allowing the actuator to hold position when un-powered. See page IMA_23 for ordering information.

NOTE: The optional Spring-Applied / Electronically Released Brake requires 24V power. Input current rating:
IMA22 - 0.35 Amps; IMA33 - 0.43 Amps;
IMA44 - 0.67 Amps; IMA55 - 0.66 Amps.

11 CHOOSE MOTOR CONNECTORS & FEEDBACK DEVICE

Connector choice and wiring emulates popular motor manufacturers for compatibility.

Current connector choices include:

- Bosch Rexroth MSK Series
- Control Techniques FM & NT
- Lenze MCA Series

Current feedback choices include:

- Incremental Encoder
- Absolute Encoder, Hiperface, Hiperface DSL, EnDat 2.2
- Resolver

Contact Tolomatic for additional motor connectors, feedback combinations and motor files for third party drives.

12 CONSIDER MOUNTING & ROD END OPTIONS

Examine mounting options dimensional drawings on page IMA_15-18. Standard mounting on the IMA are 4 tapped holes on the front rod end face of the actuator. The Side Mount option (MST) includes 12 tapped holes, 4 on each side and 4 on the bottom of the actuator. Other fixed mounting options are the Front Flange Mount (FFG) and Mounting Plates (MP2). Pivoting mount options are Front Trunnion (TRF), Rear Trunnion (TRR) and Rear Clevis Mount (PCD).

Rod End Options include: External Threaded Rod End (MET), Clevis Rod End (RCL), Spherical Rod Eye (SRE) and Alignment Coupler (ALC).

NOTE: Regardless of the mounting option chosen, care must be taken to ensure that the load is guided and in-line with the thrust rod's line of motion. Misalignment of the thrust rod's line of motion will cause degradation in the actuator's expected life.

13 CONSIDER ENVIRONMENTAL RATING AND ANTI-ROTATE OPTIONS

The environmental rating for a standard IMA is IP65, choose IP67 for protection against water and dust ingress. Choose the Anti-Rotate Option (ARO) if required. Call Tolomatic at 1-800-328-2174 for help in determining the best actuator for your application.



APPLICATION DATA WORKSHEET Fill in known data. Not all information is required for all applications

ORIENTATION

Horizontal Vertical Incline ° α

Load supported by actuator OR Load supported by other mechanism

ACTUATOR SIZING

FREE: On-line sizing and selection at sizeit.tolomatic.com

Or Call 1-800-328-2174 for Excellent Customer Service & Technical Support

MOVE PROFILE

EXTEND

Move Distance _____

inch millimeters

Move Time _____ sec

Max. Speed _____

in/sec mm/sec

Dwell Time After Move _____ sec

RETRACT

Move Distance _____

inch millimeters

Move Time _____ sec

Max. Speed _____

in/sec mm/sec

Dwell Time After Move _____ sec

NO. OF CYCLES

per minute per hour

HOLD POSITION?

Required Not Required

After Move During Power Loss

STROKE LENGTH

order in _____

mm ONLY millimeters (S M) (Metric)

NOTE: If load or force changes during cycle use the highest numbers for calculations

EXTEND	RETRACT
LOAD _____ <input type="checkbox"/> lb (U.S. Standard) <input type="checkbox"/> kg (Metric)	LOAD _____ <input type="checkbox"/> lb (U.S. Standard) <input type="checkbox"/> kg (Metric)
FORCE _____ <input type="checkbox"/> lbf (U.S. Standard) <input type="checkbox"/> N (Metric)	FORCE _____ <input type="checkbox"/> lbf (U.S. Standard) <input type="checkbox"/> N (Metric)

PRECISION

Repeatability _____

inch millimeters

OPERATING ENVIRONMENT

Temperature, Contamination, Water, etc.

MOTION PROFILE

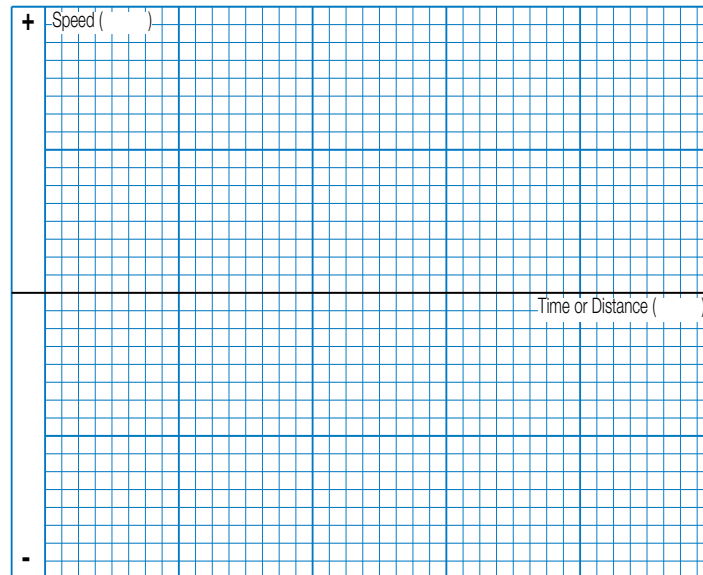

Graph your most demanding cycle, including accel/decel, velocity and dwell times. You may also want to indicate load variations and I/O changes during the cycle. Label axes with proper scale and units.

CONTACT INFORMATION

Name, Phone, Email _____

Co. Name, Etc. _____

STOP USE THE TOLOMATIC SIZING AND SELECTION SOFTWARE AVAILABLE ON-LINE AT www.tolomatic.com OR... CALL TOLOMATIC AT 1-800-328-2174. We will provide any assistance needed to determine the proper actuator for the job.

FAX 1-763-478-8080

EMAIL help@tolomatic.com

IMA - Integrated Motor Actuator

Replacement Option Parts Ordering

PART NO.	DESCRIPTION
2722-9014	Spherical Rod Eye Kit, IMA22
2733-9014	Spherical Rod Eye Kit, IMA33
2744-9014	Spherical Rod Eye Kit, IMA44
2755-9014	Spherical Rod Eye Kit, IMA55
2722-9015	Clevis Rod End Kit, IMA22
2733-9015	Clevis Rod End Kit, IMA33
2744-9015	Clevis Rod End Kit, IMA44
2755-9015	Clevis Rod End Kit, IMA55
2124-1070	Alignment Coupler Kit, IMA22
2132-1060	Alignment Coupler Kit, IMA33
2150-1060	Alignment Coupler Kit, IMA44
2164-1060	Alignment Coupler Kit, IMA55
2722-9010	Mounting Plate Kit, IMA22
2733-9010	Mounting Plate Kit, IMA33
2744-9010	Mounting Plate Kit, IMA44
2755-9010	Mounting Plate Kit, IMA55
2722-9018	Front Flange Mount Kit, IMA22
2733-9018	Front Flange Mount Kit, IMA33
2744-9018	Front Flange Mount Kit, IMA44
2755-9018	Front Flange Mount Kit, IMA55
2722-2045	Rear Clevis Mount, IMA22
2733-1045	Rear Clevis Mount, IMA33
2744-1045	Rear Clevis Mount, IMA44
2755-1045	Rear Clevis Mount, IMA55
2722-9075	Anti Rotate, Bearing Assy, IMA22
2733-9075	Anti Rotate, Bearing Assy, IMA33 & 44
2755-9075	Anti Rotate, Bearing Assy, IMA55
2722-9074	Anti Rotate, Shaft Clamp Assy, IMA22
2722-2211	Anti Rotate, Shaft, IMA22 - Indicate Stroke
2733-9074	Anti Rotate, Shaft Clamp Assy, IMA33
2733-1211	Anti Rotate, Shaft, IMA33 - Indicate Stroke
2744-9074	Anti Rotate, Shaft Clamp Assy, IMA44
2744-1211	Anti Rotate, Shaft, IMA44 - Indicate Stroke

PART NO.	DESCRIPTION
2755-9074	Anti Rotate, Shaft Clamp Assy, IMA55
2755-1211	Anti Rotate, Shaft, IMA55 - Indicate Stroke
2733-1611	Motor Power Cable, M23, 6 Pin, 5m, 460V AC
2733-1612	Motor Power Cable, M23, 6 Pin, 5m, 460V AC, Brake
2733-1613	Encoder Cable, M23, 12 Pin, 5m, Resolver/Absolute
2733-1614	Encoder Cable, M23, 17 Pin, 5m, Incremental
2744-1488	Motor Power Cable, M23, 6 Pin, 5m, 230V AC
2744-1489	Motor Power Cable, M23, 6 Pin, 5m, 230V AC, Brake
2733-1221	Motor Power Cable, M23, 6 Pin, 10m, 460V AC
2733-1222	Motor Power Cable, M23, 6 Pin, 10m, 460V AC, Brake
2733-1223	Encoder Cable, M23, 12 Pin, 10m, Resolver/Absolute
2733-1224	Encoder Cable, M23, 17 Pin, 10m, Incremental
2744-1221	Motor Power Cable, M23, 6 Pin, 10m, 230V AC
2744-1222	Motor Power Cable, M23, 6 Pin, 10m, 230V AC, Brake
2744-1016	Mobilith SHC220 Grease (Ball nut/screw)
2744-9099	Grease (Roller nut/screw)
2552-1132	Wiper, IMA22
2115-1030	Wiper, IMA33
2744-1003	Wiper, IMA44
2140-1030	Wiper, IMA55
2744-1213	Zerk Cap
2744-9092	Kit, Zerk with Cap
2744-1214	Grease Ftg. Plug

All parts are listed for REPLACEMENT ONLY. If not ordered on original unit the IMA may require additional tapped holes or replacement rod end. Contact Tolomatic.

*Not valid with DA2A2X option

IMA - Integrated Motor Actuator

Ordering

MODEL SELECTION (MUST BE IN THIS ORDER)

IMA 44 BN05 SM304-8 MV23 DT1D1 N

OPTIONS (IN ANY ORDER)

ALC MP2 IP67 CR5

MODEL

IMA Integrated Motor Actuator

IMAWP Integrated Motor Actuator

*IMAWP: lead time will vary from standard 15 day delivery, contact Tolomatic

SIZE

22 22 Series Actuator

33 33 Series Actuator

44 44 Series Actuator

55 55 Series Actuator

NUT/SCREW

Screw/Nut combinations available

22	33	44	55	Description
BN05	BN05	BN05	BN05	Ball Nut, 5 mm lead
—	BN10	BN10	BN10	Ball Nut, 10 mm lead
—	BN20	—	BN20	Ball Nut, 20 mm lead
—	—	BN25	—	Ball Nut, 25 mm lead
—	RN04	RN04	—	Roller Nut, 4 mm lead
—	RN05	RN05	RN05	Roller Nut, 5 mm lead
—	RN10	RN10	RN10	Roller Nut, 10 mm lead

STROKE LENGTH

SM Stroke, (76.2 to 457.2) enter stroke length in millimeters

NOTE: Maximum stroke for IMA22 is 12" (304.8 mm)

MOTOR VOLTAGE

MV21* 230 Vac, Motor Voltage, 1 Stack Winding

MV41* 460 Vac, Motor Voltage, 1 Stack Winding

MV23 230 Vac, Motor Voltage, 3 Stack Winding

MV43 460 Vac, Motor Voltage, 3 Stack Winding

NOTE: 22/33 size actuators only

BRAKE OPTION

N NO Brake

B Brake

ROD END OPTIONS

— **Standard**, female, internally threaded rod end

MET Male Externally Threaded Rod End

SRE Spherical Eye Rod End

RCL Clevis Rod End

ALC Alignment Coupler

NOTE: ALC (Alignment Coupler) requires ARO (Anti-Rotate) for proper operation

MOUNTING OPTIONS

— **Standard Face Mount**

MP2 Mounting Plates - 2 req.

FFG Front Flange Mount

TRF Trunnion Mount, Front

TRR Trunnion Mount, Rear

PCD Clevis Mount, Rear

MST Side Mount (tapped holes on 3 sides)

OTHER OPTIONS

IP67 Ingress Protection Rating

ARO Anti Rotate

LUB Food Grade Grease

CABLES

Tolomatic standard

CR5 6m flying lead cables, power and feedback

Tolomatic standard

CR10 10m flying lead cables, power and feedback

For custom cable lengths please contact Tolomatic. Lead times will vary.

NOTE: only use these cable options with DT1 motor connector, use cables from drive manufacturer for all others.

For IP rated cables contact Tolomatic

MOTOR SERIES CONNECTORS	FEEDBACK DEVICE
ABB Robot DA5	R1* Resolver
Aerotech BM DA7	D1* Incremental
Allen Bradley MP DA1	A1 SICK Hiperface
Allen Bradley VP DA2	A2 SICK Hiperface DSL
B&R 8LS DB7	H1* Heidenhein Endat 2.2
B&R 8LS DB7	R1* Resolver
Baldor BSM DB5	D1* Incremental
Baldor BSM DB5	R1* Resolver
Baldor BSM DB5	A1* SICK Hiperface
Baldor BSM DB5	H1* Heidenhein Endat 2.2
Beckhoff AM8 DH1	R1* Resolver
Beckhoff AM8 DH1	A1 SICK Hiperface
Bosch Rexroth MSK DB1	A1 SICK Hiperface
Bosch Rexroth MSK DB1	H1* Heidenhein Endat 2.2
Bosch Rexroth MSK DB1	R1* Resolver
Bosch Rexroth MSK DB1	D1* Incremental
Nidec/Cntl. Tech., FM DE1	A1 SICK Hiperface
Nidec/Cntl. Tech., FM DE1	H1* Heidenhein Endat 2.2
Nidec/Cntl. Tech., FM DE1	R1 Resolver
Nidec/Cntl. Tech., FM DE1	D1 Incremental

MOTOR SERIES CONNECTORS	FEEDBACK DEVICE
Nidec/Cntl. Tech., NT DE2	D1 Incremental
Fanuc Robot DF1	F1* a128 absolute
Fanuc Robot DF1	F2* a64 absolute
Kawasaki Robot DW1	K1* Absolute
Kollmorgen AKM DK1	A1* SICK Hiperface
Kollmorgen AKM DK1	H1* Heidenhein Endat 2.2
Kollmorgen AKM DK1	R1* Resolver
Kollmorgen AKM DK1	D1* Incremental
Kuka Robot DK3	R1* Resolver
Lenze MCS DL1	A1 SICK Hiperface
Lenze MCS DL1	H1* Heidenhein Endat 2.2
Lenze MCS DL1	R1 Resolver
Lenze MCS DL1	D1 Incremental
Motoman Robot DM1	M1* Absolute
Nachi Robot DN1	N1* Absolute
Omron R88 DO1	D1* Incremental
Parker MPP DP1	D1* Incremental
Parker MPP DP1	R1* Resolver
Parker MPP DP1	A1* SICK Hiperface
Parker MPP DP1	H1* Heidenhein Endat 2.2

MOTOR SERIES CONNECTORS	FEEDBACK DEVICE
Schneider Electric SH DS7	A1* SICK Hiperface
SEW CMP DS3	D1* Incremental
SEW CMP DS3	R1* Resolver
SEW CMP DS3	A1* SICK Hiperface
Siemens 1F DS1	H1 Heidenhein Endat 2.2
Siemens 1F DS1	R1* Resolver
Siemens 1F DS1	D1* Incremental
Stober DS5	R1* Resolver
Stober DS5	A1* SICK Hiperface
Stober DS5	H1* Heidenhein Endat 2.2
Tolomatic Standard DT1	D1 Incremental
Tolomatic Standard DT1	R1 Resolver
Tolomatic Standard DT1	A1 SICK Hiperface
Tolomatic Standard DT1	H1 Heidenhein Endat 2.2

*NOTE: *Contact Tolomatic for Lead Time*

***IP67 is not available with DE2 (Control Techniques NT connectors) Not available standard on IMA22*

Some feedback devices are not compatible with some connectors. **Contact Tolomatic for complete motor connector & feedback combination information**

The Tolomatic Difference Expect More From the Industry Leader:



INNOVATIVE PRODUCTS

Tolomatic designs and builds the best standard products, modified products & unique custom products for your challenging applications.



FAST DELIVERY

The fastest delivery of catalog products... Electric products are built-to-order in 15 or 20 days; Pneumatic & Power Transmission products in 5 days.



ACTUATOR SIZING

Online sizing that is easy to use, accurate and always up-to-date. Find a Tolomatic electric actuator to meet your requirements.



YOUR MOTOR HERE

Match your motor with compatible mounting plates that ship with any Tolomatic electric actuator.



LIBRARY

Easy to access CAD files available in the most popular formats to place directly into your assembly.



SUPERIOR SERVICE

Our people make the difference! Expect prompt, courteous replies to all of your application and product questions.

Also Consider These Other Tolomatic Products:

Electric Products

Rod & Guided Rod Style Actuators, High Thrust Actuators, Screw & Belt Drive Rodless Actuators, Motors, Drives and Controllers

"Foldout" Brochure #9900-9074



Pneumatic Products

Rodless Cylinders: Band Cylinders, Cable Cylinders, Magnetically Coupled Cylinders/Slides; Guided Rod Cylinder Slides

"Foldout" Brochure #9900-9075



Power Transmission Products

Gearboxes: Float-A-Shaft®, Slide-Rite®, Disc Cone Clutch; Caliper Disc Brakes

"Foldout" Brochure #9900-9076



USA

3800 County Road 116
Hamel, MN 55340, USA
Phone: (763) 478-8000
Fax: (763) 478-8080
Toll-Free: **1-800-328-2174**
sales@tolomatic.com
www.tolomatic.com

CHINA

Tolomatic Automation Products (Suzhou) Co. Ltd.
(ServoWeld® inquiries only)
No. 60 Chuangye Street, Building 2
Huqiu District, SND Suzhou
Jiangsu 215011 - P.R. China
Phone: +86 (512) 6750-8506
Fax: +86 (512) 6750-8507
ServoWeldChina@tolomatic.com

EUROPE

Tolomatic Europe GmbH
Elisabethenstr. 4 & 8
D-65428 Rüsselsheim
Germany
Phone: +49 6142 17604-0
EuropeSales@tolomatic.com

COMPANY WITH
QUALITY SYSTEM
CERTIFIED BY DNV GL
= ISO 9001 =
Certified site: Hamel, MN

All brand and product names are trademarks or registered trademarks of their respective owners. Information in this document is believed accurate at time of printing. However, Tolomatic assumes no responsibility for its use or for any errors that may

appear in this document. Tolomatic reserves the right to change the design or operation of the equipment described herein and any associated motion products without notice. Information in this document is subject to change without notice.

Visit www.tolomatic.com for the most up-to-date technical information